

DATE: 2003-02

\*D14Q299P1 REV.A  
 H3-45 VIP, ENGINE 2002  
 WITH FRONT BEAM AXLE

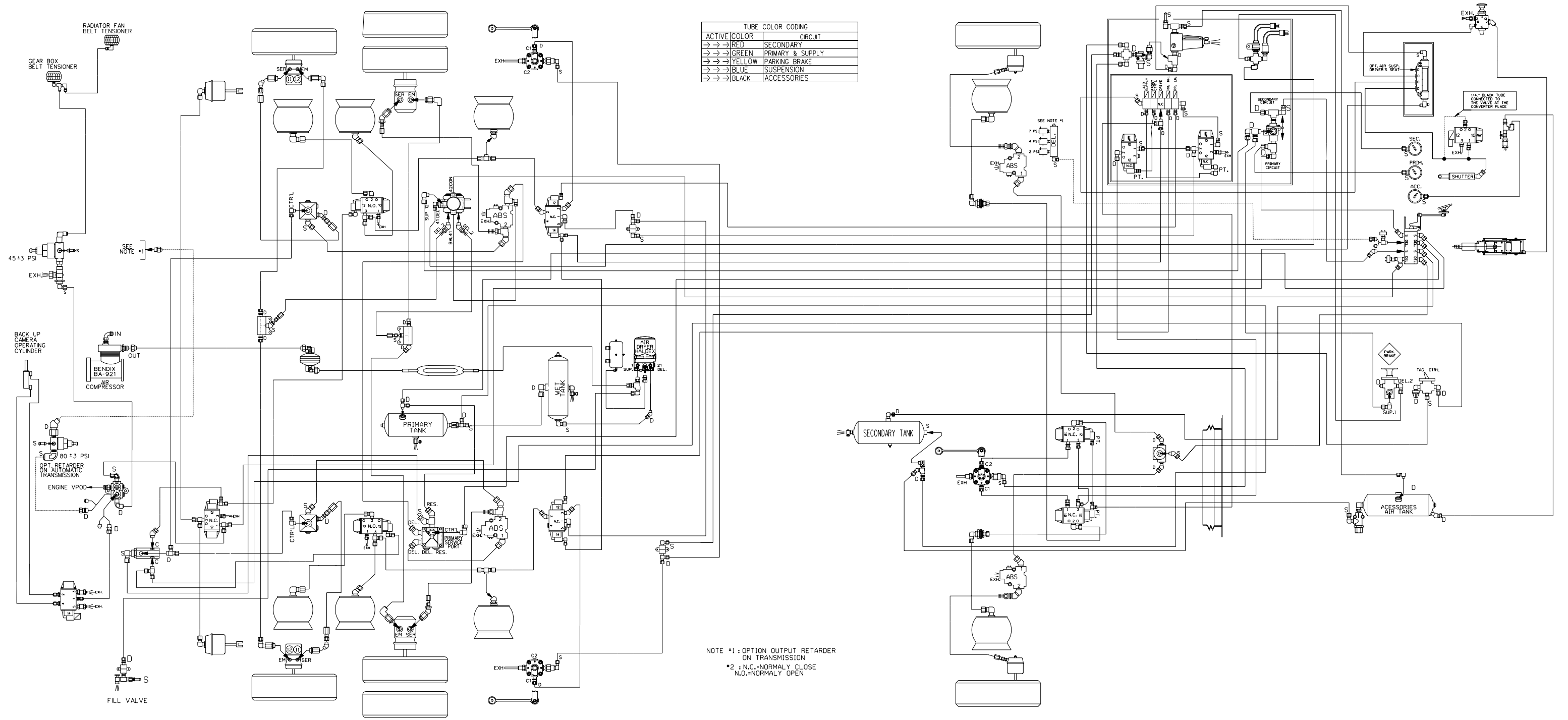

ACTIVE COLOR	CIRCUIT
→→ RED	SECONDARY
→→ GREEN	PRIMARY & SUPPLY
→→ YELLOW	PARKING BRAKE
→→ BLUE	SUSPENSION
→→ BLACK	ACCESSORIES

NOTE #1: OPTION OUTPUT RETARDER ON TRANSMISSION  
 #2: N.C.=NORMALY CLOSE  
 N.O.=NORMALY OPEN

DATE: 2004-01

#D140299P1 REV.C  
 H3-45 VIP, ENGINE 2002  
 WITH FRONT BEAM AXLE

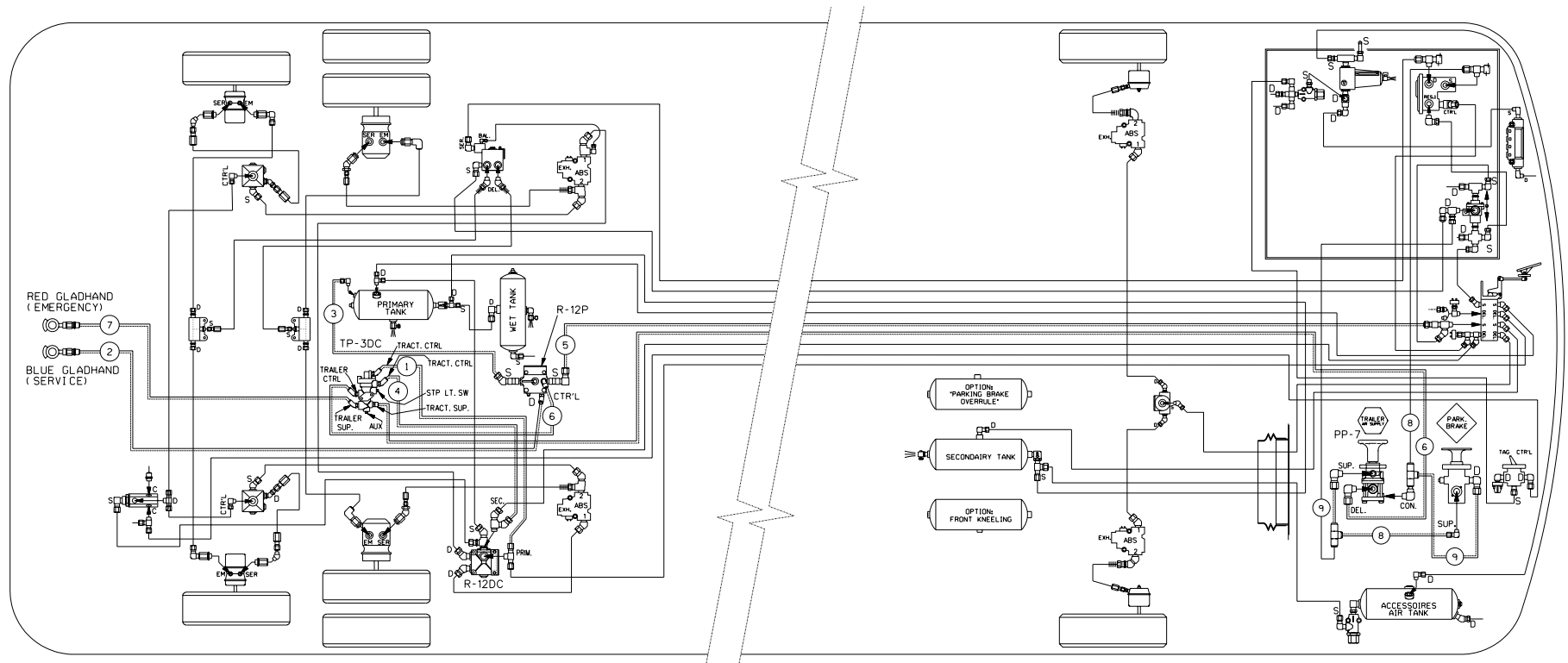

RED GLADHAND  
(EMERGENCY)

BLUE GLADHAND  
(SERVICE)

TUBE COLOR CODING	
ACTIVE COLOR	CIRCUIT
→ → → RED	SECONDARY
→ → → GREEN	PRIMARY & SUPPLY
→ → → YELLOW	PARKING BRAKE
→ → → BLUE	SUSPENSION
→ → → BLACK	ACCESSORIES

BALLOON	PIPE
*1	3/8" O.D. GREEN
*2	1/2" O.D. GREEN
*3	5/8" O.D. GREEN
*4	3/8" O.D. RED
*5	5/8" O.D. RED
*6	3/8" O.D. BROWN
*7	1/2" O.D. BROWN
*8	1/4" O.D. YELLOW
*9	3/8" O.D. YELLOW
—	STD PIPING
====	OPTIONAL PIPING

H3-45 VIP,  
ENGINE 2002 WITH  
FRONT BEAM AXLE

WITH OPTION  
TRAILER HITCH  
D140299 P2 REV. A

DATE : 2003/06

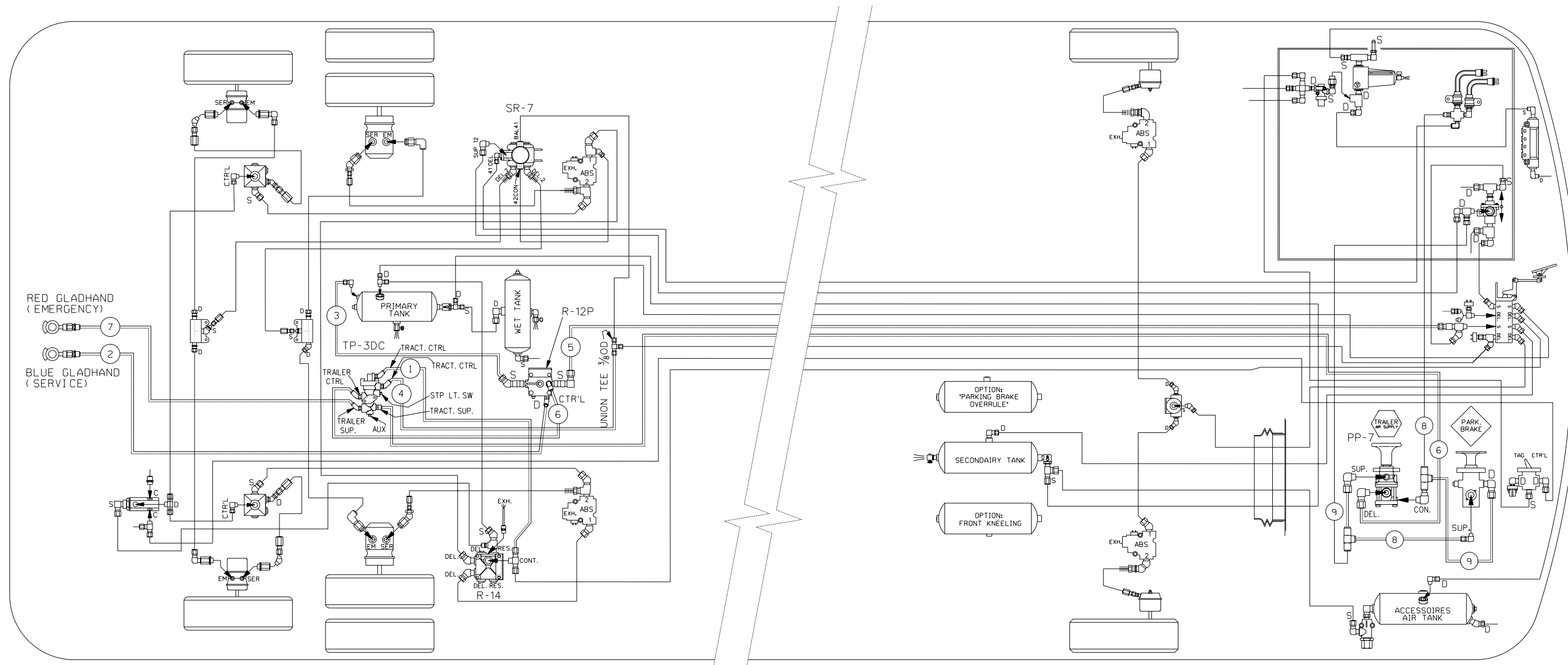

TUBE COLOR CODING		
ACTIVE	COLOR	CIRCUIT
→ → →	RED	SECONDARY
→ → →	GREEN	PRIMARY & SUPPLY
→ → →	YELLOW	PARKING BRAKE
→ → →	BLUE	SUSPENSION
→ → →	BLACK	ACCESSORIES

BALLOON	PIPE
#1	3/8" O.D. GREEN
#2	1/2" O.D. GREEN
#3	5/8" O.D. GREEN
#4	3/8" O.D. RED
#5	5/8" O.D. RED
#6	3/8" O.D. BROWN
#7	1/2" O.D. BROWN
#8	1/4" O.D. YELLOW
#9	3/8" O.D. YELLOW
=====	STD PIPING
=====	OPTIONAL PIPING

H3-45 VIP,  
ENGINE 2002 WITH  
FRONT BEAM AXLE

WITH OPTION  
TRAILER HITCH  
D1 40299 P2 REV. B

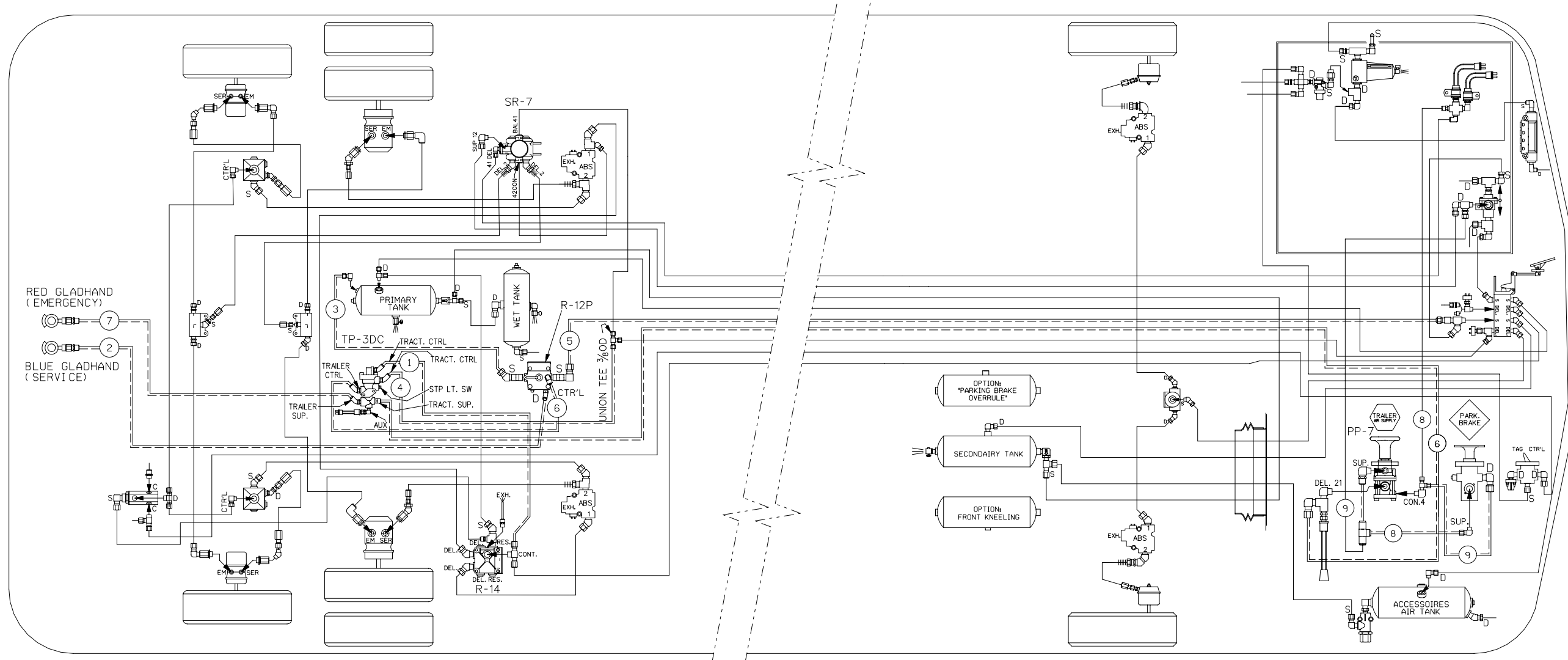

TUBE COLOR CODING	
ACTIVE COLOR	CIRCUIT
→ → → RED	SECONDARY
→ → → GREEN	PRIMARY & SUPPLY
→ → → YELLOW	PARKING BRAKE
→ → → BLUE	SUSPENSION
→ → → BLACK	ACCESSORIES

BALLOON	PIPE
#1	3/8" O.D. GREEN
#2	1/2" O.D. GREEN
#3	5/8" O.D. GREEN
#4	3/8" O.D. RED
#5	5/8" O.D. RED
#6	3/8" O.D. BROWN
#7	1/2" O.D. BROWN
#8	1/4" O.D. YELLOW
#9	3/8" O.D. YELLOW
—	STD PIPING
---	OPTIONAL PIPING

H3-45 VIP,  
ENGINE 2002 WITH  
FRONT BEAM AXLE

WITH OPTION  
TRAILER HITCH  
D140299 P2 REV.C

DATE : 2004/11

TUBE COLOR CODING	
ACTIVE COLOR	CIRCUIT
→ →	RED SECONDARY
→ →	GREEN PRIMARY & SUPPLY
→ →	YELLOW PARKING BRAKE
→ →	BLUE SUSPENSION
→ →	BLACK ACCESSORIES

BALLOON	PIPE
*1	1/4" O.D. BLACK
*2	3/8" O.D. BLACK
*3	3/8" O.D. YELLOW

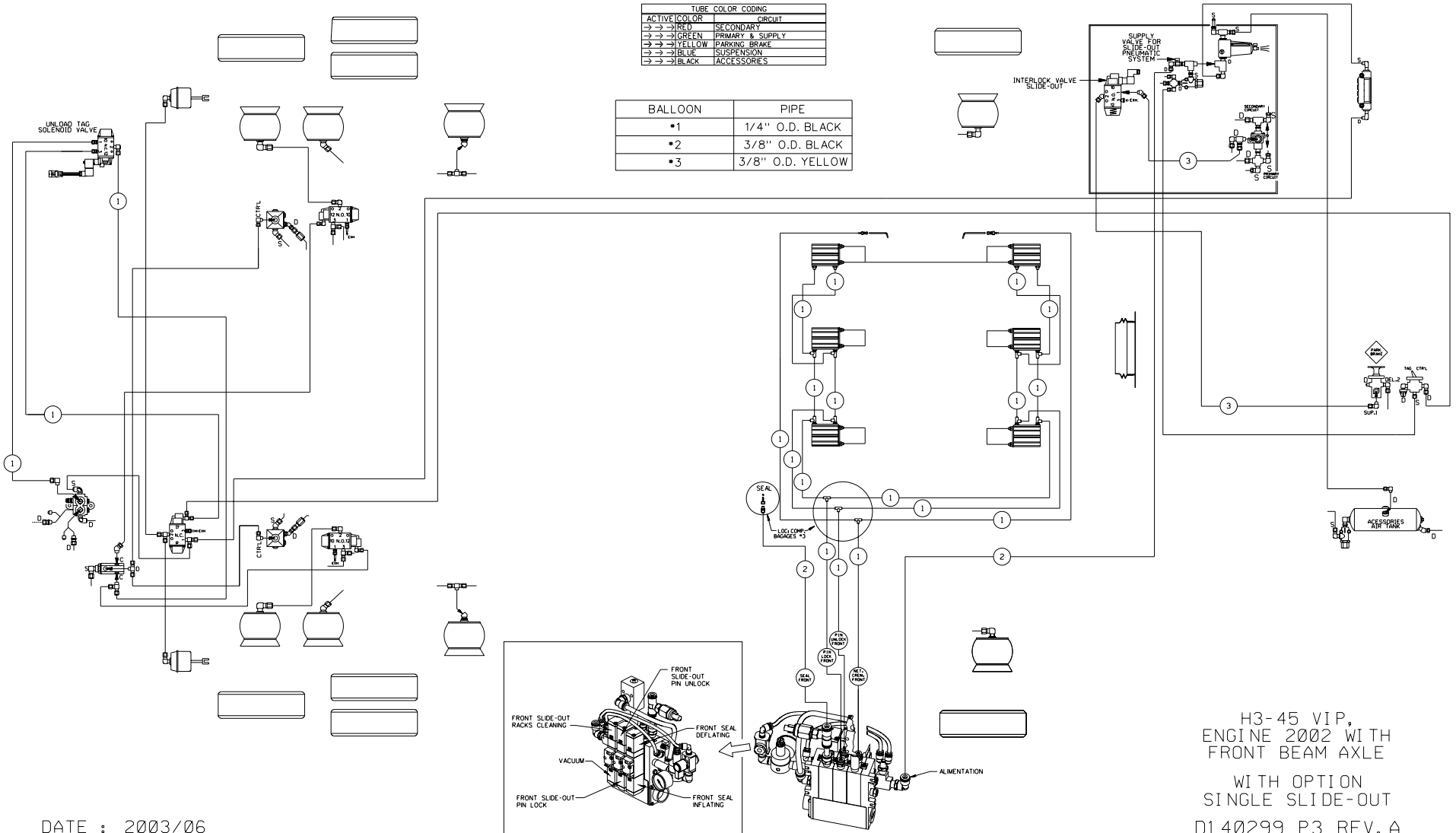

H3-45 VIP,  
 ENGINE 2002 WITH  
 FRONT BEAM AXLE  
 WITH OPTION  
 SINGLE SLIDE-OUT  
 D140299 P3 REV. A

TUBE COLOR CODING		
ACTIVE	COLOR	CIRCUIT
→ →	RED	SECONDARY
→ →	GREEN	PRIMARY & SUPPLY
→ →	YELLOW	PARKING BRAKE
→ →	BLUE	SUSPENSION
→ →	BLACK	ACCESSORIES

BALLOON	PIPE
#1	1/4" O.D. BLACK
#2	3/8" O.D. BLACK
#3	3/8" O.D. YELLOW

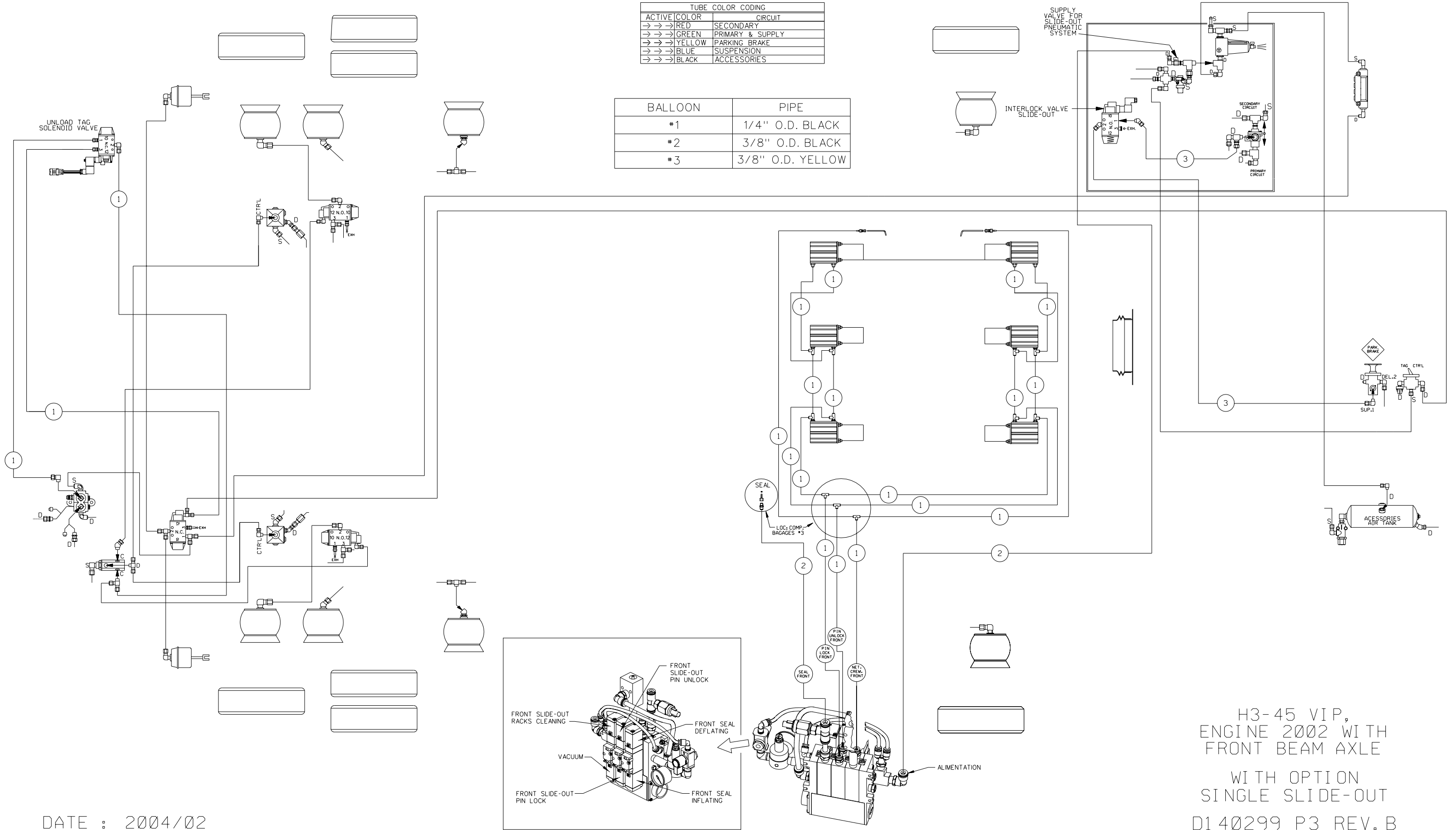

H3-45 VIP,  
ENGINE 2002 WITH  
FRONT BEAM AXLE  
  
WITH OPTION  
SINGLE SLIDE-OUT  
D1 40299 P3 REV. B

DATE : 2004/02





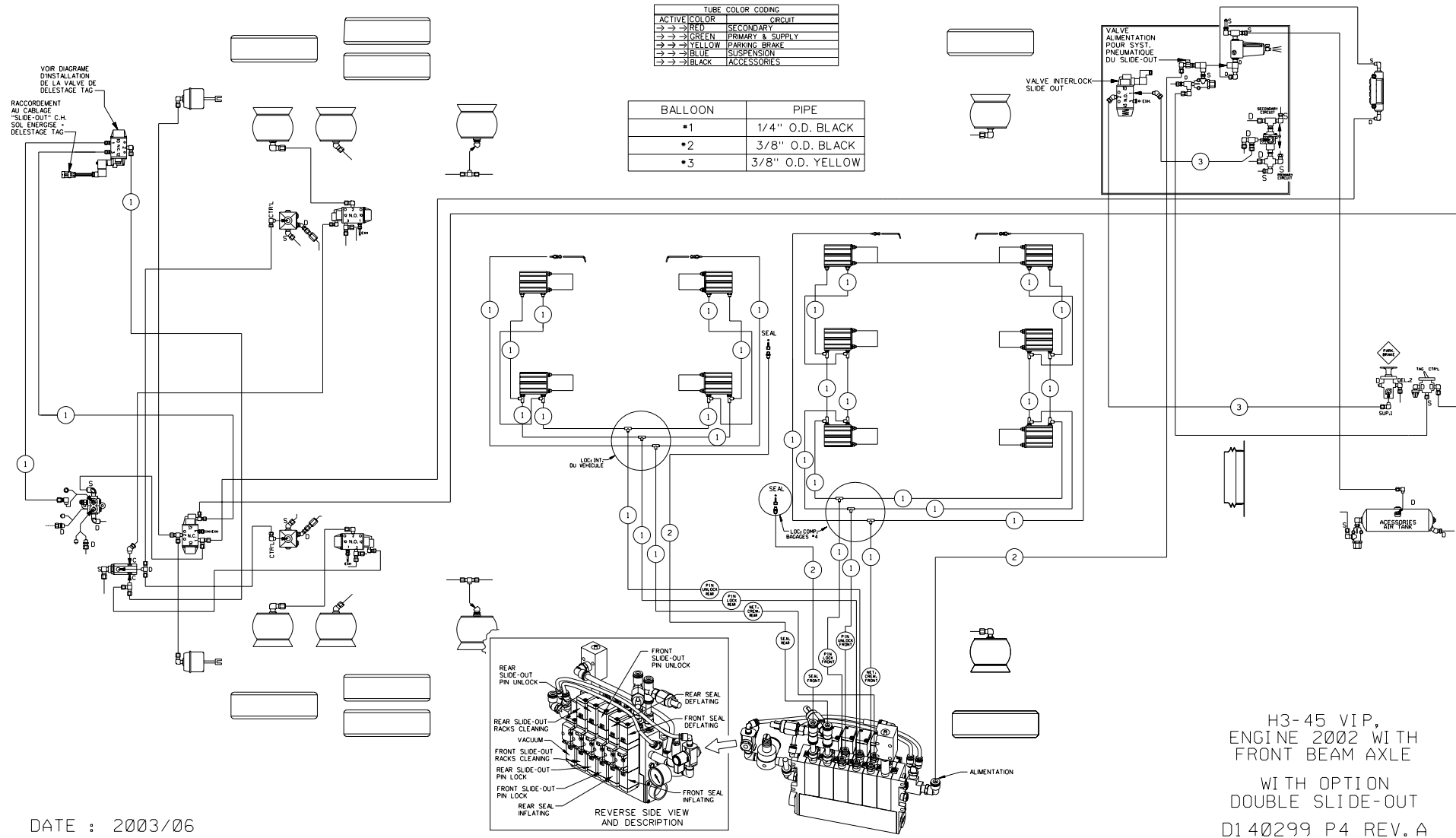

DATE : 2003/06

H3-45 VIP,  
ENGINE 2002 WITH  
FRONT BEAM AXLE  
  
WITH OPTION  
DOUBLE SLIDE-OUT  
D1 40299 P4 REV. A

TUBE COLOR CODING	
ACTIVE COLOR	CIRCUIT
→ → → RED	SECONDARY
→ → → GREEN	PRIMARY & SUPPLY
→ → → YELLOW	PARKING BRAKE
→ → → BLUE	SUSPENSION
→ → → BLACK	ACCESSORIES

BALLOON	PIPE
#1	1/4" O.D. BLACK
#2	3/8" O.D. BLACK
#3	3/8" O.D. YELLOW

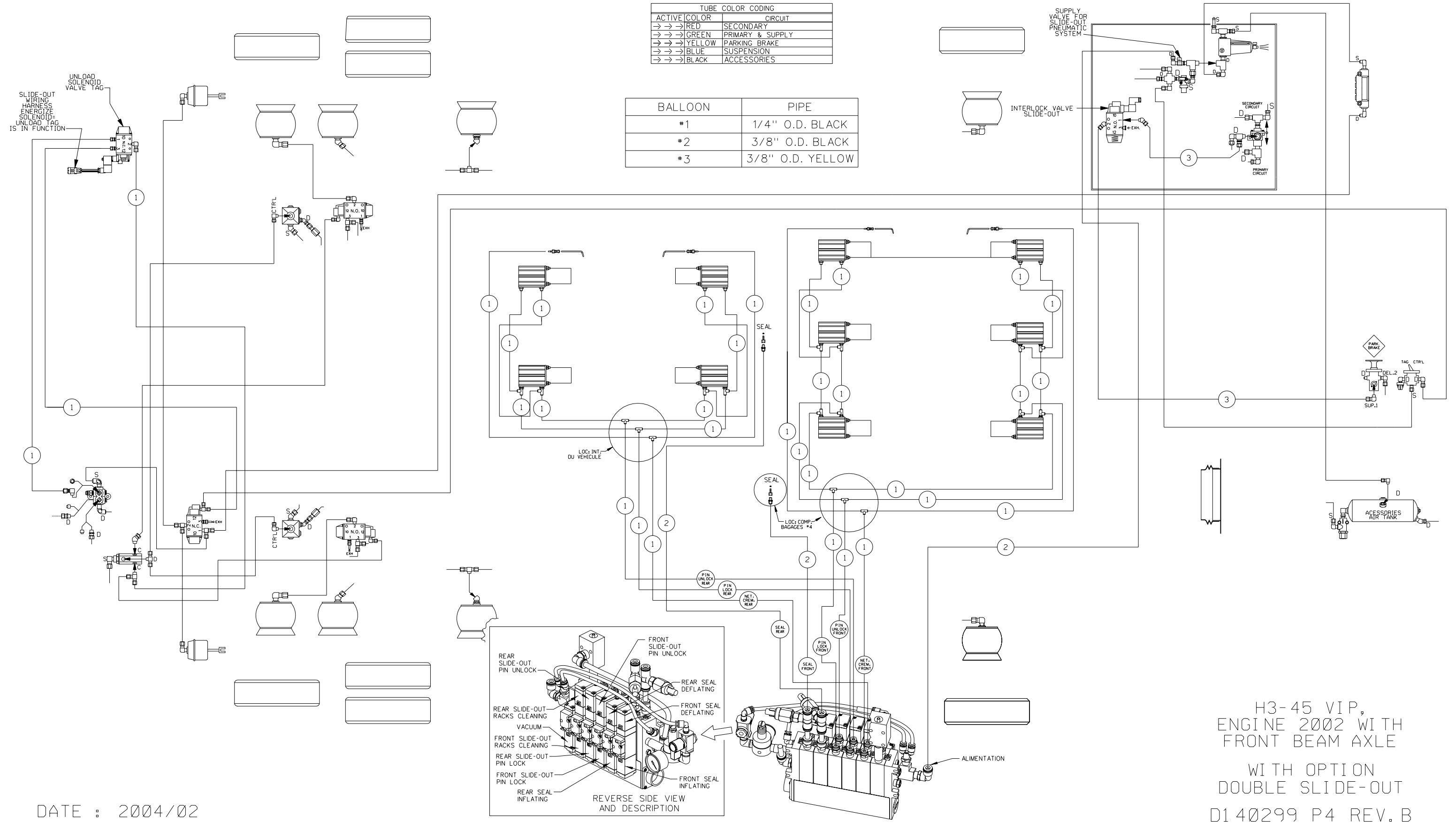

DATE : 2004/02

H3-45 VIP,  
ENGINE 2002 WITH  
FRONT BEAM AXLE

WITH OPTION  
DOUBLE SLIDE-OUT  
D1 40299 P4 REV. B

TUBE COLOR CODING	
ACTIVE COLOR	CIRCUIT
→ → → RED	SECONDARY
→ → → GREEN	PRIMARY & SUPPLY
→ → → YELLOW	PARKING BRAKE
→ → → BLUE	SUSPENSION
→ → → BLACK	ACCESSORIES

BALLOON	PIPE
#1	1/4" O.D. BLACK
#2	3/8" O.D. BLACK
#3	3/8" O.D. YELLOW

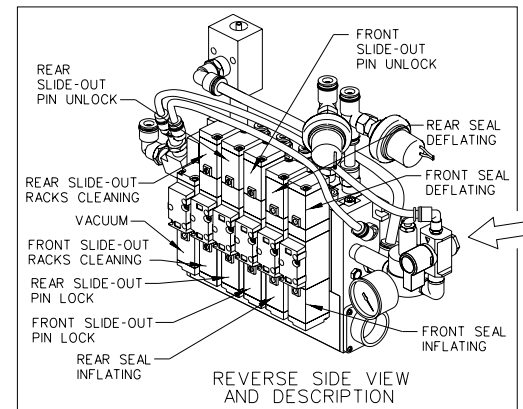
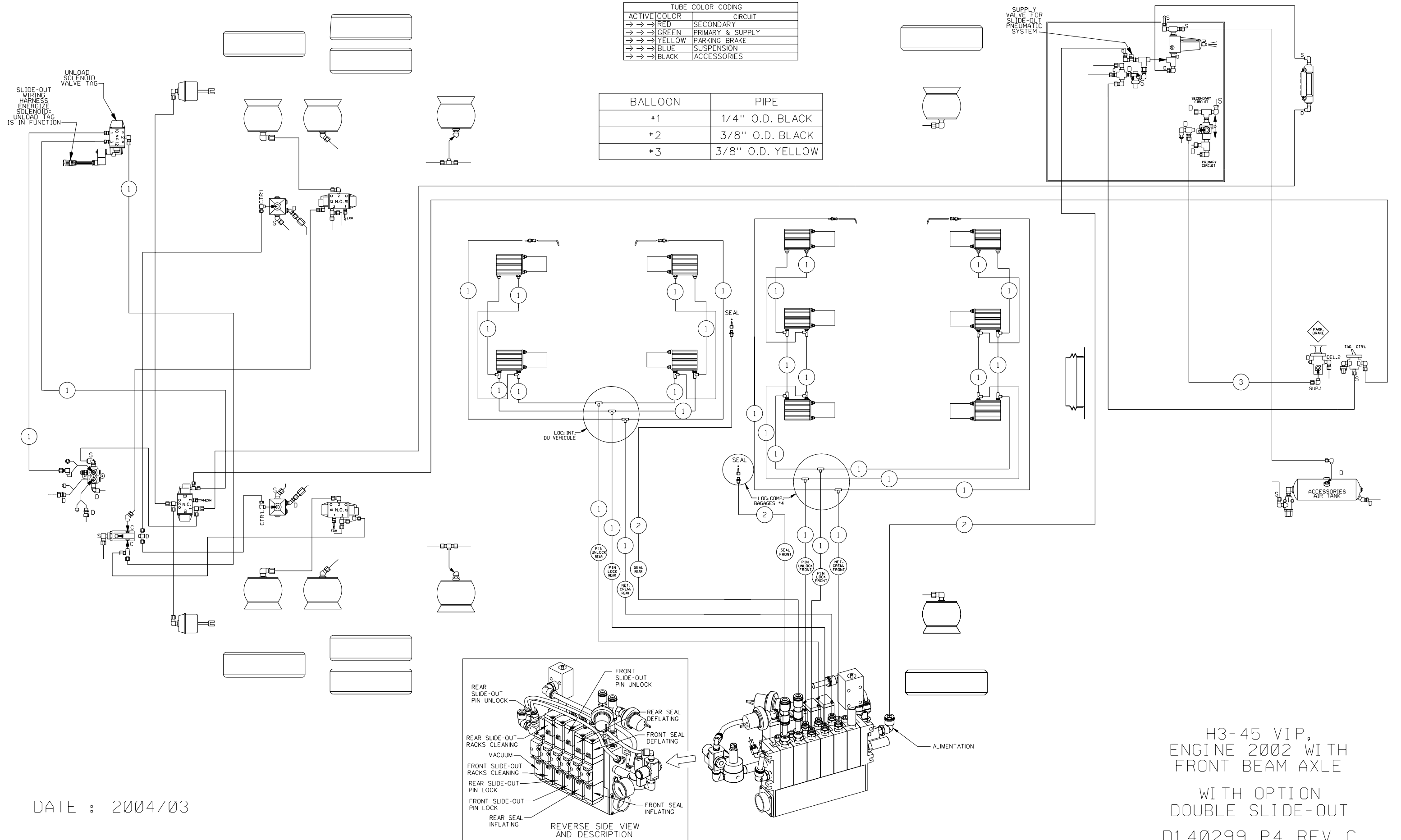

DATE : 2004/03

H3-45 VIP,  
ENGINE 2002 WITH  
FRONT BEAM AXLE  
  
WITH OPTION  
DOUBLE SLIDE-OUT  
D140299 P4 REV.C